

LCD Digital Colour TV

Operating Instructions

Setting Up

Watching TV

Additional Information

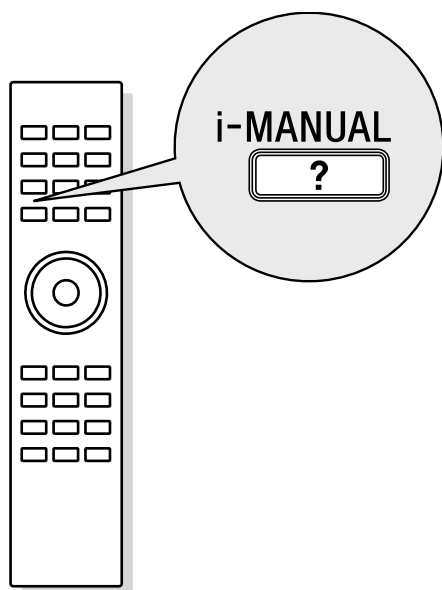

BRAVIA

NOTICE FOR CUSTOMERS IN THE UNITED KINGDOM

A moulded plug complying with BS1363 is fitted to this equipment for your safety and convenience.

Should the fuse in the plug supplied need to be replaced with the same rating of fuse approved by ASTA or BSI to BS 1362 (i.e., marked with \diamond or \heartsuit) must be used. When an alternative type of plug is used it should be fitted with the same rating of fuse, otherwise the circuit should be protected by a 10 AMP FUSE at the distribution board.

If the plug supplied with this equipment has a detachable fuse cover, be sure to attach the fuse cover after you change the fuse. Never use the plug without the fuse cover. If you should lose the fuse cover, please contact your nearest Sony service station.

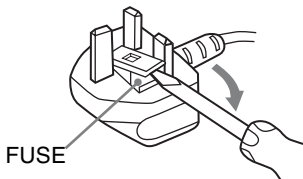
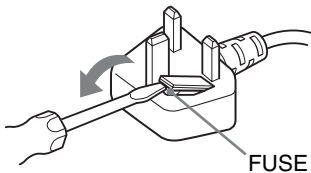

How to replace the fuse

Open the fuse compartment with a blade screwdriver, and replace the fuse. Please refer to the illustration that actually equipped with the product.

Introduction

Thank you for choosing this Sony product. Before operating the TV, please read this manual thoroughly and retain it for future reference.

The manufacturer of this product is Sony Corporation, 1-7-1 Konan Minato-ku Tokyo, 108-0075 Japan. The Authorized Representative for EMC and product safety is Sony Deutschland GmbH, Hedelfinger Strasse 61, 70327 Stuttgart, Germany. For any service or guarantee matters please refer to the addresses given in separate service or guarantee documents.

Notes on Digital TV function

- Any functions related to Digital TV (DVB) will only work in countries or areas where DVB-T (MPEG-2 and H.264/MPEG-4 AVC) digital terrestrial signals are broadcast or where you have access to a compatible DVB-C (MPEG-2 and H.264/MPEG-4 AVC) cable service. Please confirm with your local dealer if you can receive a DVB-T signal where you live or ask your cable provider if their DVB-C cable service is suitable for integrated operation with this TV.
- Your cable provider may charge a fee for their services, or require you to agree to its terms and conditions of business.
- This TV set complies with DVB-T and DVB-C specifications, but compatibility with future DVB-T digital terrestrial and DVB-C digital cable broadcasts are not guaranteed.
- Some Digital TV functions may not be available in some countries/areas and DVB-C cable may not operate correctly with some providers.

For a list of compatible cable providers, refer to the support web site:

<http://support.sony-europe.com/TV/DVBC/>



- Instructions about "Installing Wall Mount Bracket" are included within this TV's instructions manual.
- The illustrations used in this manual are of the KDL-40EX703 series unless otherwise state.

Trademark information

DVB is a registered trademark of the DVB Project.

HDMI, the HDMI logo and High-Definition Multimedia Interface are trademarks or registered trademarks of HDMI Licensing LLC.

DLNA and DLNA CERTIFIED are trademarks and/or service marks of Digital Living Network Alliance.

DivX® is a video file compression technology, developed by DivX, Inc.

DivX, DivX Certified, and associated logos are trademarks of DivX, Inc. and are used under license.

ABOUT DIVX VIDEO: DivX® is a digital video format created by DivX, Inc. This is an official DivX Certified device that plays DivX video. Visit www.divx.com for more information and software tools to convert your files into DivX video.

ABOUT DIVX VIDEO-ON-DEMAND: This DivX Certified® device must be registered in order to play DivX Video-on-Demand (VOD) content. To generate the registration code, locate the DivX VOD section in the device setup menu. Go to vod.divx.com with this code to complete the registration process and learn more about DivX VOD.

Manufactured under license from Dolby Laboratories. Dolby and the double-D symbol are trademarks of Dolby Laboratories.

"BRAVIA" and BRAVIA are trademarks of Sony Corporation.

"XMB™" and "XrossMediaBar" are trademarks of Sony Corporation and Sony Computer Entertainment Inc.

HDMI™
HIGH-DEFINITION MULTIMEDIA INTERFACE

DOLBY
DIGITAL PLUS

dlna™
CERTIFIED

Table of Contents

Checking the accessories	3
Inserting batteries into the remote	3

Setting Up

Attaching the Table-Top Stand (except for KDL-60EX703)	4
Connecting an antenna (aerial)/Set Top Box/recorder (e.g. DVD recorder)	4
Preventing the TV from toppling over	5
Bundling the cables	5
Performing the initial set-up	6
Detaching the Table-Top Stand from the TV	6

Watching TV

To watch programmes	7
To utilise the TV's features	7
To use i-Manual	8

Additional Information

Troubleshooting	9
Specifications	10
Installing the Accessories (Wall-Mount Bracket)	12
TV installation dimensions table	13
Screw and Hook locations diagram/table	14
Safety Information	15
Precautions	16

- Operating instructions are built into your BRAVIA TV. Refer to "To use i-Manual" for operation (page 8).
- Before operating the TV, please read "Safety Information" (page 15). Retain this manual for future reference.

Checking the accessories

AC power cord (mains lead) (1)

Remote (1)

Size AAA batteries (R3 type) (2)

Cable holder (1)

Stand rear cover (1)*¹

(KDL-40/32EX703 and KDL-40/32EX603 only)

Table-Top Stand (1)*²

(except for KDL-60EX703)

Fixing screws for stand (M5 × 16) (4)

(except for KDL-60EX703)

Assembling screws for stand (M5 × 16) (4)

(KDL-40/32EX703 and KDL-40/32EX603 only)

*¹ For KDL-60/52/46EX703, the stand rear cover is factory-attached to the stand.

*² For KDL-40/32EX703 and KDL-40/32EX603, assemble the Table-Top Stand with the supplied assembling screws.

Refer to the supplied Table-Top Stand leaflet to assemble the stand.

Inserting batteries into the remote

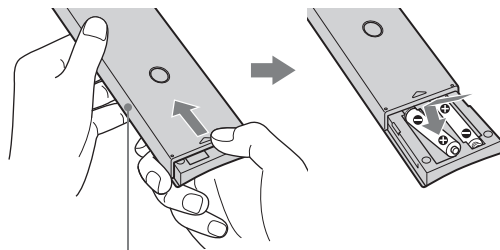

Slide the cover to open.

Attaching the Table-Top Stand (except for KDL-60EX703)

- 1 Refer to the supplied Table-Top Stand leaflet for proper attachment for some TV models.
- 2 Place the TV set on the Table-Top Stand.

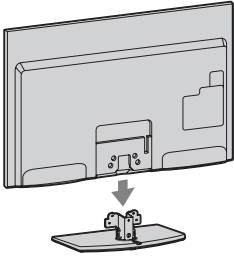

- 3 Fix the TV to the Table-Top Stand according to the arrow marks  that guide the screw holes using the supplied screws.

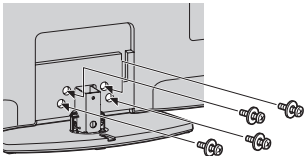

- If using an electric screwdriver, set the tightening torque at approximately 1.5 N·m {15 kgf·cm}.

- 4 For KDL-40/32EX703 and KDL-40/32EX603, after all the screws are tightened, attach the supplied stand rear cover to the Table-Top Stand.

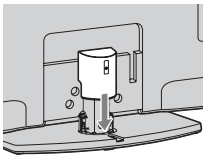

Connecting an antenna (aerial)/Set Top Box/recorder (e.g. DVD recorder)

Connecting a Set Top Box/recorder (e.g. DVD recorder) with SCART

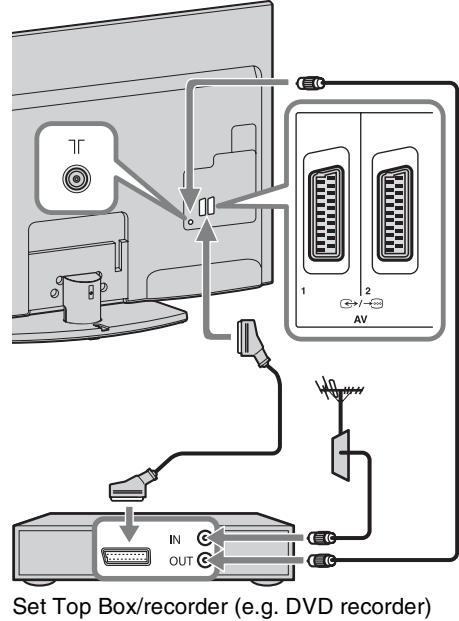

Connecting a Set Top Box/recorder (e.g. DVD recorder) with HDMI

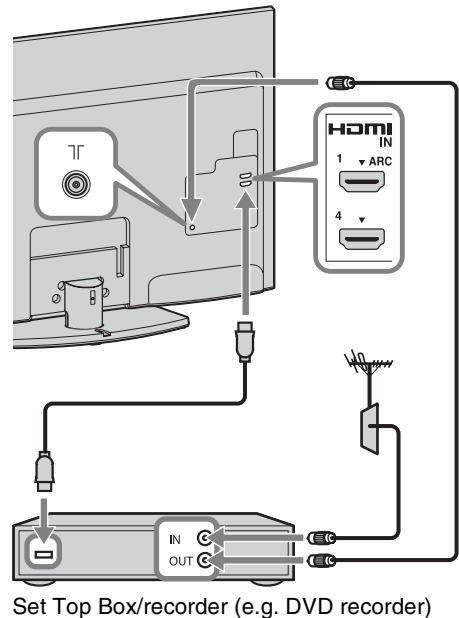

Preventing the TV from toppling over

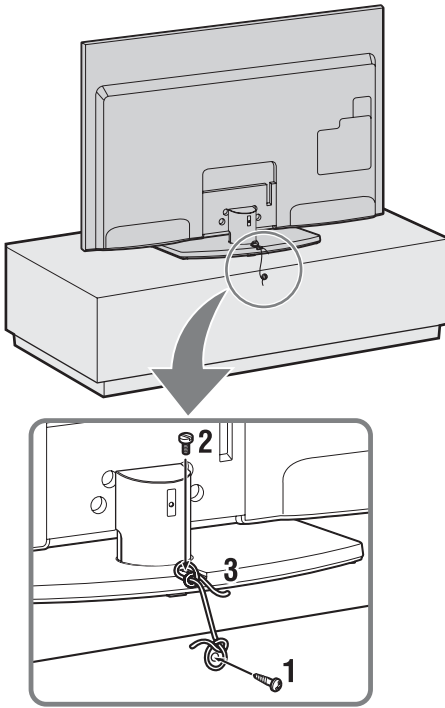

- 1** Install a wood screw (4 mm in diameter, not supplied) in the TV stand.
- 2** Install a machine screw (M4 × 16, not supplied) into the screw hole of the TV.
- 3** Tie the wood screw and the machine screw with a strong cord (not supplied).

Bundling the cables

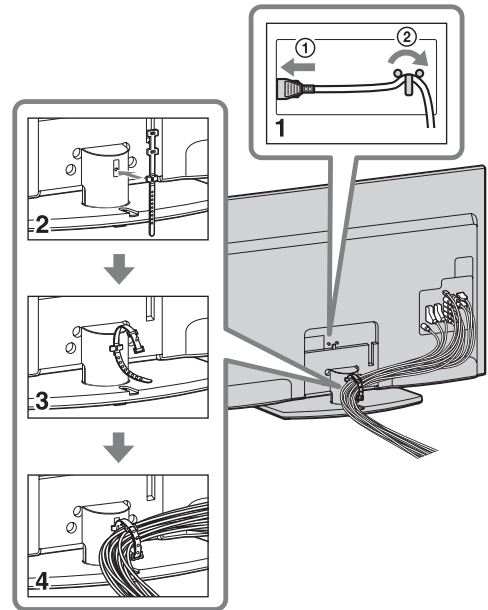

- Do not bundle the AC power cord (mains lead) together with other cables.

Performing the initial set-up

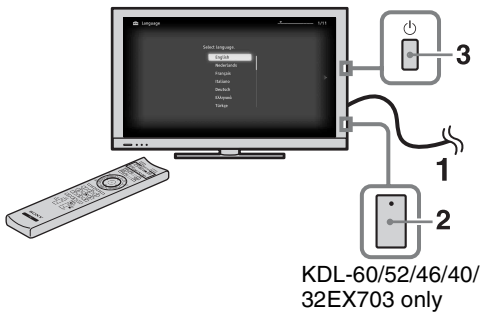

- 1 Connect the TV to your AC power outlet (mains socket).
- 2 For KDL-60/52/46/40/32EX703, check the **ENERGY SAVING SWITCH** setting is on (●).
- 3 Press  on the TV.
When you switch on the TV for the first time, the Language menu appears on the screen.

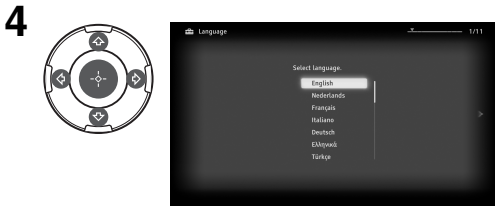





Follow the instructions on the screen.

Digital Auto Tuning: When you select “Cable”, we recommend that you select “Quick Scan” for quick tuning. Set “Frequency” and “Network ID” according to the information supplied from your cable provider. If no channel is found using “Quick Scan”, try “Full Scan” (though it may take some time).

For a list of compatible cable providers, refer to the support web site:
<http://support.sony-europe.com/TV/DVBC/>

Programme Sorting: Changes the order of analogue channels stored in the TV.

- 1 Press  to select the channel you want to move to a new position, then press .
- 2 Press  to select the new position for the channel, then press .



- You can also tune channels manually.

Detaching the Table-Top Stand from the TV

Remove the screws guided by the arrow marks  of the TV.

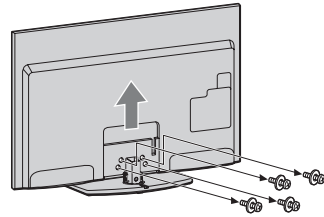

- Do not remove the Table-Top Stand for any reason other than to install corresponding accessories on the TV.
- Do not hold by the stand rear cover while carrying the Table-Top Stand to prevent dropping the stand which may cause an injury or damage to the property.

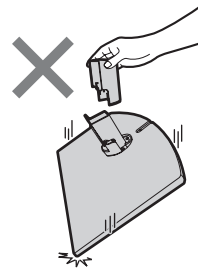

Watching TV

To watch programmes

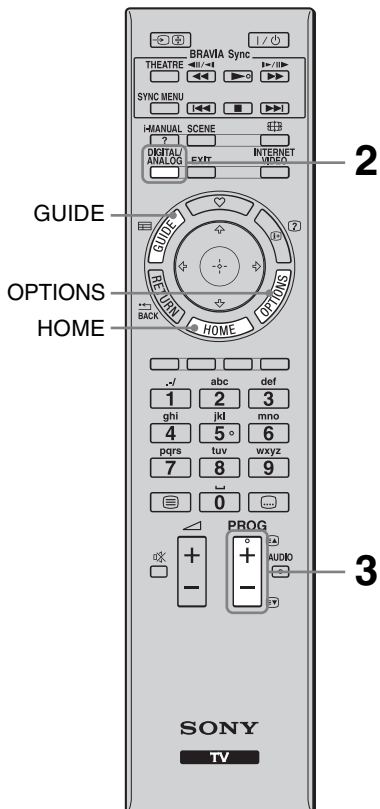

1 Turn on the TV.

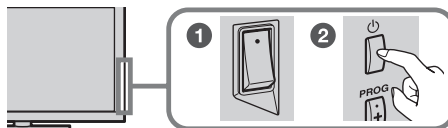

- 1 For KDL-60/52/46/40/32EX703, switch **ENERGY SAVING SWITCH** on (●).
- 2 Press on the TV to turn on the TV.

2 Select a mode.



3 Select a TV channel.

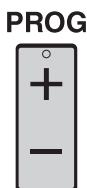

Using Digital Electronic Programme Guide

Press **GUIDE** in digital mode to display the programme guide.



- The number **5**, , **PROG +** and **AUDIO** buttons on the remote have a tactile dot. Use the tactile dots as a reference when operating the TV.

To utilise the TV's features

HOME button

Press to display various operation and setting screens.

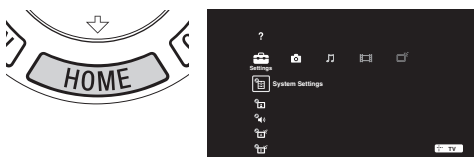

OPTIONS button

Press to display convenient functions based on the current input or content.



To use i-Manual

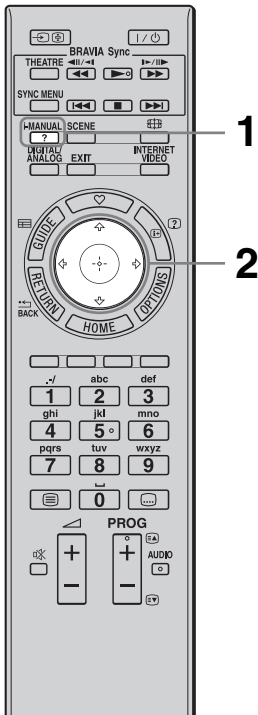

Operating instructions are built into your BRAVIA TV and can be displayed on the screen. You can browse your i-Manual anytime you need to find the varieties of convenient functions.

1 Press i-MANUAL.



2 Press $\leftarrow/\rightarrow/\uparrow/\downarrow/\oplus$ to select items.

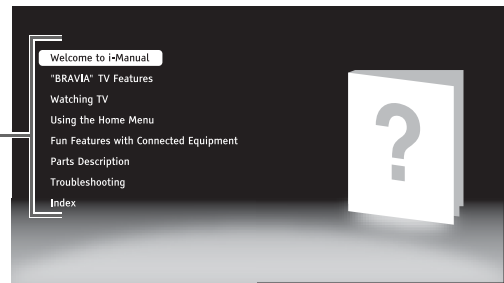
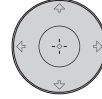

■ Welcome to i-Manual

■ “BRAVIA” TV Features

■ Watching TV

Introduces convenient features such as EPG Guide, Favourites, etc.

■ Using the HOME Menu

Customise your TV settings, etc.



- Images and illustrations may differ from what is displayed on the screen.

■ Fun Features with Connected Equipment

Introduces how to connect optional equipment.

■ Parts Description

■ Troubleshooting

Find solutions for your problem.



■ Index

Troubleshooting

Check whether the  (standby) indicator is flashing in red.



When the (standby) indicator is flashing

The self-diagnosis function is activated.













- 1 Count how many times the  (standby) indicator flashes between each three second break.
For example, the indicator may flash three times, go off for three seconds, then flash again three times.
- 2 Press  on the TV to turn it off, disconnect the AC power cord (mains lead), and inform your dealer or Sony service centre of how the indicator flashes (number of flashes).

When the (standby) indicator is not flashing

- 1 Check the items in the tables below. (Also refer to “Troubleshooting” in the i-Manual.)
- 2 If the problem persists, have your TV serviced by qualified service personnel.

Condition	Explanation/Solution
Picture	
There is no picture (screen is dark) and no sound.	<ul style="list-style-type: none"> • Check the antenna (aerial)/cable connection. • Connect the TV to the AC power (mains), and press  on the TV. • If the  (standby) indicator lights up in red, press .
Tiny black points and/or bright points appear on the screen.	<ul style="list-style-type: none"> • The screen is composed of pixels. Tiny black points and/or bright points (pixels) on the screen do not indicate a malfunction.
General	
The TV's power cannot be turned on (KDL-60/52/46/40/32EX703 only).	<ul style="list-style-type: none"> • Check if ENERGY SAVING SWITCH is on (●).
The TV turns off automatically (the TV enters standby mode).	<ul style="list-style-type: none"> • Check if the “Sleep Timer” is activated, or confirm the “Duration” setting of “On Timer”. • Check if the “Idle TV Standby” is activated.
The remote does not function.	<ul style="list-style-type: none"> • Replace the batteries. • Your TV may be in SYNC mode. Press SYNC MENU, select “TV Control” and then select “Home (Menu)” or “Options” to control the TV.
The “Parental Lock” password has been forgotten.	<ul style="list-style-type: none"> • Enter 9999 for the PIN code. (PIN code 9999 is always accepted.)

Specifications

System	
Panel system	LCD (Liquid Crystal Display) Panel
TV system	Analogue: Depending on your country/area selection: B/G/H, D/K, L, I Digital: DVB-T2/DVB-T/DVB-C
Colour/video system	Analogue: PAL, PAL60 (only video input), SECAM, NTSC3.58, NTSC4.43 (only video input) Digital: MPEG-2 MP@ML/HL, H.264/MPEG-4 AVC MP/HP@L4
Channel coverage	Analogue: VHF: E2–E12/UHF: E21–E69/CATV: S1–S20/HYPER: S21–S41 D/K: R1–R12, R21–R69/L: F2–F10, B–Q, F21–F69/I: UHF B21–B69 Digital: VHF/UHF
Sound output	10 W + 10 W
Input/Output jacks	
Aerial/Antenna cable	75 ohm external terminal for VHF/UHF
 AV1, 2	21-pin scart connector (CENELEC standard) including audio/video input, RGB input and TV audio/video output.
 COMPONENT IN	Supported formats: 1080p, 1080i, 720p, 576p, 576i, 480p, 480i
 COMPONENT IN	Audio input (phono jacks)
HDMI IN1, 2, 3, 4	Video: 1080/24p, 1080p, 1080i, 720p, 576p, 576i, 480p, 480i Audio: Two channel linear PCM: 32, 44.1 and 48 kHz, 16, 20 and 24 bits, Dolby Digital Analogue audio input (minijack) (HDMI IN4 only) PC Input
 AV3	Video input (phono jack)
 AV3	Audio input (phono jacks)
 DIGITAL AUDIO OUT (OPTICAL)	Digital optical jack (Two channel linear PCM, Dolby Digital)
 (VAR/FIX)	Audio output (phono jacks)
 PC IN	PC Input (Mini D-sub 15-pin)  PC audio input (minijack)
	USB port
	Headphones jack
	CAM (Conditional Access Module) slot
 LAN	10BASE-T/100BASE-TX connector (Depending on the operating environment of the network, connection speed may differ. 10BASE-T/100BASE-TX communication rate and communication quality are not guaranteed for this TV.) * For LAN connections, use a Category 7 10BASE-T/100BASE-TX cable (not supplied).

Model name KDL-		60EX703	52EX703	46EX703
Power and others				
Power requirements		220 V – 240 V AC, 50 Hz		
Screen size (measured diagonally)		Approx. 152.5 cm/60 inches	Approx. 132.2 cm/52 inches	Approx. 116.8 cm/46 inches
Display resolution		1,920 dots (horizontal) × 1,080 lines (vertical)		
Power consumption	in “Home”/“Standard” mode	144 W	103 W	90.0 W
	in “Shop”/“Vivid” mode	208 W	142 W	125 W
Standby power consumption* ¹		0.23 W (15 W when “Quick Start” is set to “On”)		
Average annual energy consumption* ²		210 kWh	150 kWh	131 kWh
Dimensions (Approx.) (w × h × d)				
with Table-Top Stand		143.1 × 90.9 × 38.6 cm	125.2 × 80.5 × 35.0 cm	111.8 × 73.0 × 28.0 cm
without Table-Top Stand		143.1 × 87.7 × 6.6 cm	125.2 × 77.5 × 6.5 cm	111.8 × 69.8 × 6.5 cm
Mass (Approx.)				
with Table-Top Stand		38.1 kg	27.0 kg	21.3 kg
without Table-Top Stand		31.3 kg	22.7 kg	18.4 kg
Supplied accessories		See “Checking the accessories” (page 3).		
Optional accessories		Wall-Mount Bracket: SU-WL500		

Model name KDL-		40EX703	40EX603	32EX703	32EX603
Power and others					
Power requirements		220 V – 240 V AC, 50 Hz			
Screen size (measured diagonally)		Approx. 101.6 cm/40 inches	Approx. 101.6 cm/40 inches	Approx. 80.1 cm/32 inches	Approx. 80.1 cm/32 inches
Display resolution		1,920 dots (horizontal) × 1,080 lines (vertical)			
Power consumption	in “Home”/“Standard” mode	79.0 W	73.0 W	67.0 W	58.0 W
	in “Shop”/“Vivid” mode	107 W	98 W	91 W	80 W
Standby power consumption* ¹		0.2 W (15 W when “Quick Start” is set to “On”)			
Average annual energy consumption* ²		115 kWh	107 kWh	98 kWh	85 kWh
Dimensions (Approx.) (w × h × d)					
with Table-Top Stand		98.5 × 65.5 × 28.0 cm	95.2 × 61.3 × 25.0 cm	81.1 × 53.9 × 25.0 cm	76.4 × 50.7 × 25.0 cm
without Table-Top Stand		98.5 × 62.3 × 6.4 cm	95.2 × 58.1 × 7.4 cm	81.1 × 50.7 × 6.5 cm	76.4 × 47.5 × 7.3 cm
Mass (Approx.)					
with Table-Top Stand		17.8 kg	14.9 kg	12.7 kg	11.1 kg
without Table-Top Stand		14.9 kg	12.7 kg	10.7 kg	9.1 kg
Supplied accessories		See “Checking the accessories” (page 3).			
Optional accessories		Wall-Mount Bracket: SU-WL500			

*¹ Specified standby power is reached after the TV finishes necessary internal processes.

*² 4 hours a days and 365 days a year



- To save power consumption
 - when you reduce backlight setting (the brightness of the screen), the power consumption reduce.
 - the “Eco” settings (e.g. “Power Saving”, “Idle TV Standby”) help you to reduce the power consumption and thus save money by reducing electricity bills.
 - when you switch off the TV using the **ENERGY SAVING SWITCH** (only certain models), power consumption will be almost zero.

Design and specifications are subject to change without notice.

Installing the Accessories (Wall-Mount Bracket)

To Customers:

For product protection and safety reasons, Sony strongly recommends that installing of your TV be performed by Sony dealers or licensed contractors. Do not attempt to install it yourself.

To Sony Dealers and Contractors:

Provide full attention to safety during the installation, periodic maintenance and examination of this product.

Your TV can be installed using the SU-WL500 Wall-Mount Bracket (sold separately).

- Refer to the Instructions supplied with the Wall-Mount Bracket to properly carry out the installation.
- Refer to “Detaching the Table-Top Stand from the TV” (page 6).



- Place the TV on the Table-Top Stand, when securing the Mounting Hook.
- For KDL-60/52/46/40/32EX703:
 - Be sure to store the removed screws in a safe place, keeping them away from children.
 - When attaching the Table-Top Stand again, be sure to fasten the removed screws to the original holes on the rear of the TV.

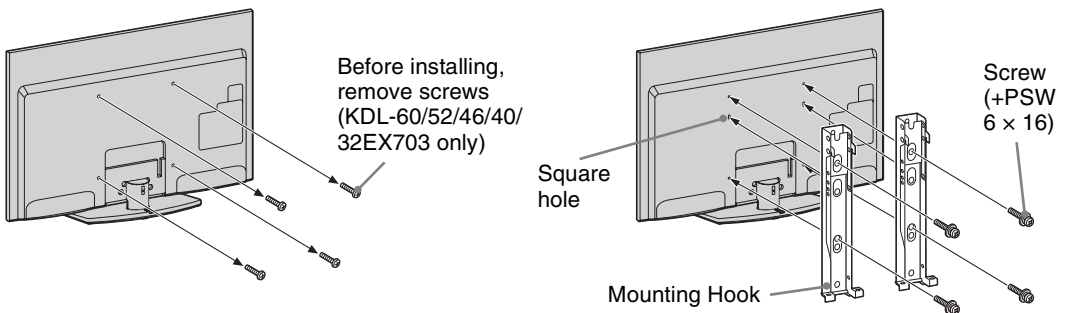

Sufficient expertise is required for installing this product, especially to determine the strength of the wall for withstanding the TV's weight. Be sure to entrust the attachment of this product to the wall to Sony dealers or licensed contractors and pay adequate attention to safety during the installation. Sony is not liable for any damage or injury caused by mishandling or improper installation.

TV installation dimensions table

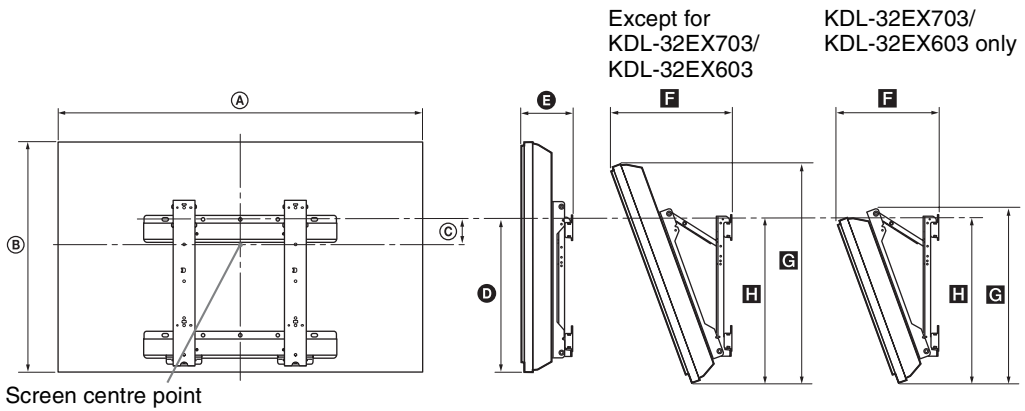

Unit: cm

Model Name KDL-	Display dimensions		Screen centre dimension C	Length for each mounting angle				
	A	B		Angle (0°)		Angle (20°)		
				D	E	F	G	H
60EX703	143.1	87.7	3.1	48.3	11.5	37.5	82.4	50.1
52EX703	125.2	77.5	8.2	48.3	11.4	33.9	72.8	50.1
46EX703	111.8	69.8	12.1	48.3	11.4	31.3	65.6	50.1
40EX703	98.5	62.3	15.8	48.3	11.4	28.7	58.5	50.1
40EX603	95.2	58.1	13.3	43.1	12.0	29.7	54.6	45.4
32EX703	81.1	50.7	19.7	45.9	11.5	25.7	49.7	47.8
32EX603	76.4	47.5	18.5	43.1	12.0	26.0	47.3	45.4

Figures in the above table may differ slightly depending on the installation.

WARNING

The wall that the TV will be installed on should be capable of supporting a weight of at least four times that of the TV. Refer to “Specifications” (page 10) for its weight.

Screw and Hook locations diagram/table

Model Name	Screw location	Hook location
KDL-60EX703	e, j	a
KDL-52EX703 KDL-46EX703 KDL-40EX703 KDL-40EX603		b
KDL-32EX703 KDL-32EX603		c

Screw location

When installing the Mounting Hook on the TV.

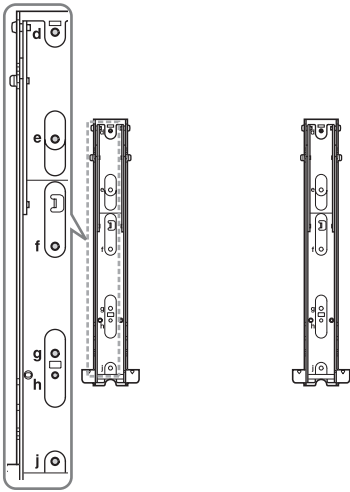

Hook location

When installing the TV onto the Base Bracket.

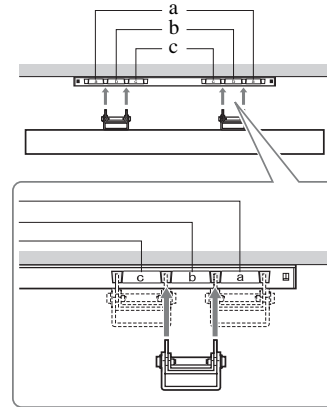

Safety Information

Installation/Set-up

Install and use the TV set in accordance with the instructions below in order to avoid any risk of fire, electrical shock or damage and/or injuries.

Installation

- The TV set should be installed near an easily accessible mains socket.
- Place the TV set on a stable, level surface.
- Only qualified service personnel should carry out wall installations.
- For safety reasons, it is strongly recommended that you use Sony accessories, including:
 - Wall-mount bracket SU-WL500
- Be sure to use the screws supplied with the Wall-mount bracket when attaching the mounting hooks to the TV set. The supplied screws are designed so that they are 8 mm to 12 mm in length when measured from the attaching surface of the mounting hook.

The diameter and length of the screws differ depending on the Wall-mount bracket model.

Use of screws other than those supplied may result in internal damage to the TV set or cause it to fall, etc.

8 mm - 12 mm

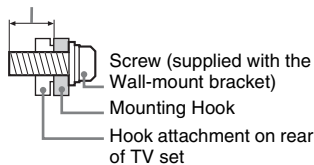

Transporting

- Before transporting the TV set, disconnect all cables.
- Two or three people are needed to transport a large TV set.
- When transporting the TV set by hand, hold it as shown on the right. Do not put stress on the LCD panel and the frame around the screen.
- When lifting or moving the TV set, hold it firmly from the bottom.
- When transporting the TV set, do not subject it to jolts or excessive vibration.
- When transporting the TV set for repairs or when moving, pack it using the original carton and packing material.

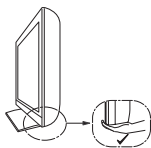

Ventilation

- Never cover the ventilation holes or insert anything in the cabinet.
- Leave space around the TV set as shown below.
- It is strongly recommended that you use a Sony wall-mount bracket in order to provide adequate air-circulation.

Installed on the wall

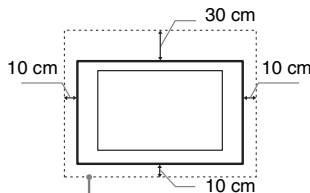

Leave at least this space around the set.

Installed with stand

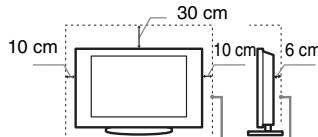

Leave at least this space around the set.

- To ensure proper ventilation and prevent the collection of dirt or dust:
 - Do not lay the TV set flat, install upside down, backwards, or sideways.
 - Do not place the TV set on a shelf, rug, bed or in a closet.
 - Do not cover the TV set with a cloth, such as curtains, or items such as newspapers, etc.
 - Do not install the TV set as shown below.

Air circulation is blocked.

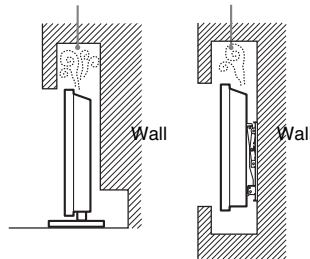

Mains lead

Handle the mains lead and socket as follows in order to avoid any risk of fire, electrical shock or damage and/or injuries:

- Use only mains leads supplied by Sony, not other suppliers.
- Insert the plug fully into the mains socket.
- Operate the TV set on a 220-240 V AC supply only.
- When wiring cables, be sure to unplug the mains lead for your safety and take care not to catch your feet on the cables.
- Disconnect the mains lead from the mains socket before working on or moving the TV set.
- Keep the mains lead away from heat sources.

- Unplug the mains plug and clean it regularly. If the plug is covered with dust and it picks up moisture, its insulation may deteriorate, which could result in a fire.

Notes

- Do not use the supplied mains lead on any other equipment.
- Do not pinch, bend, or twist the mains lead excessively. The core conductors may be exposed or broken.
- Do not modify the mains lead.
- Do not put anything heavy on the mains lead.
- Do not pull on the mains lead itself when disconnecting the mains lead.
- Do not connect too many appliances to the same mains socket.
- Do not use a poor fitting mains socket.

Prohibited Usage

Do not install/use the TV set in locations, environments or situations such as those listed below, or the TV set may malfunction and cause a fire, electrical shock, damage and/or injuries.

Location:

Outdoors (in direct sunlight), at the seashore, on a ship or other vessel, inside a vehicle, in medical institutions, unstable locations, near water, rain, moisture or smoke.

Environment:

Places that are hot, humid, or excessively dusty; where insects may enter; where it might be exposed to mechanical vibration, near flammable objects (candles, etc). The TV set shall not be exposed to dripping or splashing and no objects filled with liquids, such as vases, shall be placed on the TV.

Situation:

Do not use when your hands are wet, with the cabinet removed, or with attachments not recommended by the manufacturer. Disconnect the TV set from mains socket and aerial during lightning storms.

Broken pieces:

- Do not throw anything at the TV set. The screen glass may break by the impact and cause serious injury.
- If the surface of the TV set cracks, do not touch it until you have unplugged the mains lead. Otherwise electric shock may result.

When not in use

- If you will not be using the TV set for several days, the TV set should be disconnected from the mains for environmental and safety reasons.
- As the TV set is not disconnected from the mains when the TV set is just turned off, pull the plug from the mains to disconnect the TV set completely.
- However, some TV sets may have features that require the TV set to be left in standby to work correctly.

For children

- Do not allow children to climb on the TV set.
- Keep small accessories out of the reach of children, so that they are not mistakenly swallowed.

If the following problems occur...

Turn off the TV set and unplug the mains lead immediately if any of the following problems occur.

Ask your dealer or Sony service centre to have it checked by qualified service personnel.

When:

- Mains lead is damaged.
- Poor fitting of mains socket.
- TV set is damaged by being dropped, hit or having something thrown at it.
- Any liquid or solid object falls through openings in the cabinet.

Warning

To prevent the spread of fire, keep candles or other open flames away from this product at all time.



Precautions

Viewing the TV

- View the TV in moderate light, as viewing the TV in poor light or during long period of time, strains your eyes.
- When using headphones, adjust the volume so as to avoid excessive levels, as hearing damage may result.

LCD Screen

- Although the LCD screen is made with high-precision technology and 99.99% or more of the pixels are effective, black dots may appear or bright points of light (red, blue, or green) may appear constantly on the LCD screen. This is a structural property of the LCD screen and is not a malfunction.
- Do not push or scratch the front filter, or place objects on top of this TV set. The image may be uneven or the LCD screen may be damaged.
- If this TV set is used in a cold place, a smear may occur in the picture or the picture may become dark. This does not indicate a failure. These phenomena disappear as the temperature rises.
- Ghosting may occur when still pictures are displayed continuously. It may disappear after a few moments.
- The screen and cabinet get warm when this TV set is in use. This is not a malfunction.
- The LCD screen contains a small amount of liquid crystal. Some fluorescent tubes used in this TV set also contain mercury. Follow your local ordinances and regulations for disposal.

Handling and cleaning the screen surface/cabinet of the TV set

Be sure to unplug the mains lead connected to the TV set from mains socket before cleaning.

To avoid material degradation or screen coating degradation, observe the following precautions.

- To remove dust from the screen surface/cabinet, wipe gently with a soft cloth. If dust is persistent, wipe with a soft cloth slightly moistened with a diluted mild detergent solution.
- Do not spray water or detergent directly on the TV set. It may drip to the bottom of the screen or exterior parts, and may cause a malfunction.
- Never use any type of abrasive pad, alkaline/acid cleaner, scouring powder, or volatile solvent, such as alcohol, benzene, thinner or insecticide. Using such materials or maintaining prolonged contact with rubber or vinyl materials may result in damage to the screen surface and cabinet material.
- Periodic vacuuming of the ventilation openings is recommended to ensure to proper ventilation.
- When adjusting the angle of the TV set, move it slowly so as to prevent the TV set from moving or slipping off from its table stand.

Optional Equipment

- Keep optional components or any equipment emitting electromagnetic radiation away from the TV set. Otherwise picture distortion and/or noisy sound may occur.
- This equipment has been tested and found to comply with the limits set out in the EMC Directive using a connection signal cable shorter than 3 meters.

Batteries

- Observe the correct polarity when inserting batteries.
- Do not use different types of batteries together or mix old and new batteries.
- Dispose of batteries in an environmentally friendly way. Certain regions may regulate the disposal of batteries. Please consult your local authority.
- Handle the remote with care. Do not drop or step on it, or spill liquid of any kind onto it.
- Do not place the remote in a location near a heat source, a place subject to direct sunlight, or a damp room.

Disposal of the TV set



Disposal of Old Electrical & Electronic Equipment (Applicable in the European

Union and other European countries with separate collection systems)

This symbol on the product or on its packaging indicates that this product shall not be treated as household waste. Instead it shall be handed over to the applicable collection point for the recycling of electrical and electronic equipment. By

ensuring this product is disposed of correctly, you will help prevent potential negative consequences for the environment and human health, which could otherwise be caused by inappropriate waste handling of this product. The recycling of materials will help to conserve natural resources. For more detailed information about recycling of this product, please contact your local Civic Office, your household waste disposal service or the shop where you purchased the product.



Disposal of waste batteries (applicable in the European Union and other European

countries with separate collection systems)

This symbol on the battery or on the packaging indicates that the battery provided with this product shall not be treated as household waste. On certain batteries this symbol might be used in combination with a chemical symbol. The chemical symbols for mercury (Hg) or lead (Pb) are added if the battery contains more than 0.0005% mercury or 0.004% lead. By ensuring these batteries are disposed of correctly, you will help prevent potentially negative consequences for the environment and human health which could otherwise be caused by inappropriate waste handling of the battery. The recycling of the materials will help to conserve natural resources. In case of products that for safety, performance or data integrity reasons require a permanent connection with an incorporated battery, this battery should be replaced by qualified service staff only. To ensure that the battery will be treated properly, hand over the product at end-of-life to the applicable collection point for the recycling of electrical and electronic equipment. For all other batteries, please view the section on how to remove the battery from the product safely. Hand the battery over to the applicable collection point for the recycling of waste batteries. For more detailed information about recycling of this product or battery, please contact your local Civic Office, your household waste disposal service or the shop where you purchased the product.

Keep this important information about how to re-tune your TV during the digital TV switchover

Keep this Instruction manual safe you'll need it

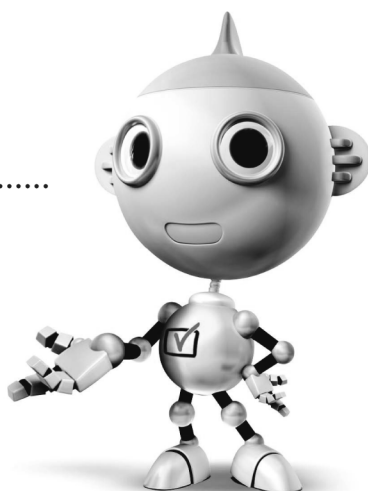

Television in the UK is going digital, bringing us all more.

Please see overleaf to find out when your area switches to digital.

Digital UK is the independent, non-profit organisation leading the process of digital TV switchover in the UK. Digital UK provides impartial information on what people need to do to prepare for the move to digital, and when they need to do it.

How the switchover affects your TV equipment:

Your new TV has a digital tuner built in, which means it is ready to receive the Freeview signal by simply plugging it into your aerial socket (check if you can get digital TV through your aerial now, or whether you'll have to wait until switchover, at www.digitaluk.co.uk).

When the TV switchover happens in your area, there are at least two occasions when you will need to re-tune your TV in order to continue receiving your existing TV channels, and also to pick up new ones. Digital UK, the body leading the digital TV switchover, will advise you when you need to re-tune during the switchover.

How to re-tune:

- 1 Press **"HOME"** on the remote
- 2 Press ⇐/⇒ to select "Settings"
- 3 Press ⇐/⇒ to select "Digital Set-up", then press ⊕
- 4 Press ⊕ to select "Digital Auto Tuning"
- 5 Press ⇐ to select "Yes" then press ⊕ to start "Digital Auto Tuning"
- 6 Follow the on screen instructions.

If you are missing any channels, it may be that they are not available in your area, or that your aerial needs upgrading.

If you have any questions, please contact Sony on **08705 111 999** or call Digital UK on **0845 6 50 50 50** or visit **www.digitaluk.co.uk**

When does switchover happen?

*Copeland switches on October 17, 2007

The exact date you switch depends on the transmitter you are served by. To check when you switch, go to Digital UK's postcode checker on www.digitaluk.co.uk

Check your ITV news service or look at Teletext page 106 to see what TV region you're in.



Visit us at digitaluk.co.uk call us on **0845 6 50 50 50†**

†Calls charged at BT rate of 3p per minute daytime and 1p per minute evenings and weekends. Rates may vary for calls from non-BT lines.



For useful information about Sony products

<http://www.sony-europe.com/myproduct/>



4180171131

4-180-171-13(1)

<http://www.sony.net/>

© 2010 Sony Corporation